

WATTNODE[®] WIDE-RANGE MODBUS[®]

Electric Power Meter - Installation Guide

Model: WND-WR-MB

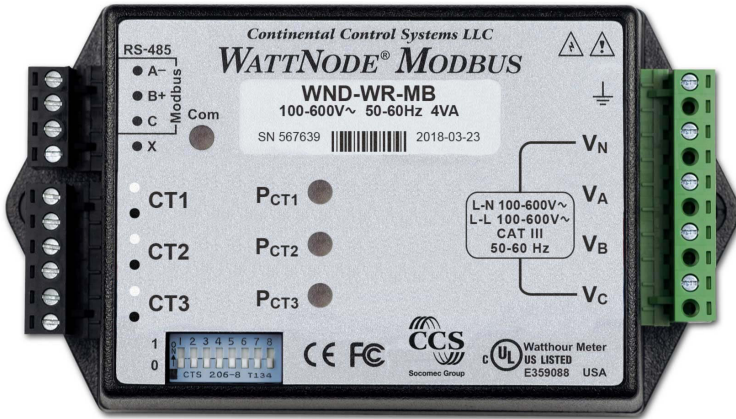

**Continental
Control
Systems, LLC**

Socomec Group

www.ctlsys.com

Contents

1	Precautions	3
1.1	Symbols	3
2	Overview	3
2.1	Additional Literature	3
2.2	Electrical Service Types	4
3	Installation	6
3.1	Installation Checklist	6
3.2	Mounting	7
3.3	Connect Voltage Terminals	7
3.4	Connect Current Transformers	7
3.5	RS-485 Communication	8
4	Operation	10
4.1	Initial Configuration	10
4.2	Power Status LEDs	10
4.3	Modbus Communication LED	11
4.4	Monitoring	12
4.5	Maintenance and Repair	12
5	Specifications	12
5.1	Measurement	12
5.2	Electrical	12
5.3	EIA RS-485 Interface	13
5.4	Certifications	13
5.5	Environmental	14
5.6	Mechanical	14
5.7	FCC Information	14
5.8	Warranty	16
5.9	Limitation of Liability	16

1 Precautions

- Only **licensed electricians** or qualified personnel should install the WattNode meter. The mains voltages of 100 to 600 Vac can be lethal!
- Follow all applicable local and national electrical and safety codes.
- The terminal block screws are **not** insulated. Do not contact metal tools to the screw terminals if the circuit is live!
- Verify that circuit voltages and currents are within the proper range for the meter model.
- Use only UL Listed or Recognized current transformers (CTs). Depending on the meter options, you may use either CTs with built-in burden resistors that generate 0.333 Vac (333 millivolts AC) at rated current or milliamp output CTs that generate 40 mA at rated current. **Do not use 1 amp or 5 amp output CTs: they will destroy the meter and may create a shock hazard.**
- Protect the line voltage conductors to the meter with fuses or circuit breakers. See **3.3.1** below.
- Disconnect equipment from HAZARDOUS LIVE voltages before access.
- If the meter is not installed correctly, the safety protections may be impaired.

1.1 Symbols



Read, understand, and follow all instructions including warnings and precautions before installing and using the product.



Potential Shock Hazard from Dangerous High Voltage.



Functional ground; should be connected to earth ground if possible, but is not required for safety grounding.



UL Listing mark for U.S.A. and Canada.



FCC Mark. This logo indicates compliance with part 15 of the FCC rules.



Complies with the regulations of the European Union for Product Safety and Electro-Magnetic Compatibility.

- Low Voltage Directive – EN 61010-1:2010 (3rd Edition)
- EMC Directive – EN 61326-1:2013



This indicates an AC voltage.

2 Overview

Congratulations on your purchase of the WattNode® Wide-Range Modbus® watt/watt-hour meter. One model can measure 100 to 600 Vac, single-phase or three-phase, wye or delta services. It is designed for use in demand side management (DSM), submetering, energy monitoring, billing and renewable energy applications. The WattNode meter communicates on an EIA RS-485 two-wire bus using the Modbus RTU protocol.

The WattNode Wide-Range Modbus meets the revenue metering ANSI C12.1 Class 1 standard when used with class 0.6 current transformers and meets ANSI C12.20 Class 0.5 when used with class 0.2 or class 0.3 current transformers.

2.1 Additional Literature

See the Continental Control Systems, LLC website (ctlsys.com) for product pages, datasheets, and support pages for all WattNode meter models and current transformers. The WattNode Wide-Range has a [Reference Manual](#) with detailed information on the available measurements and interface.

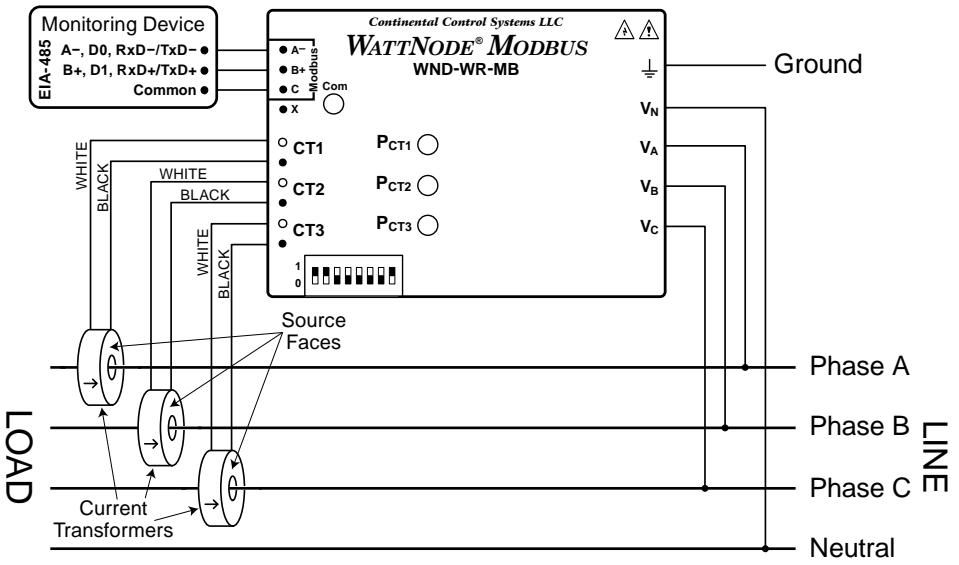

Figure 1: Wiring Diagram

2.2 Electrical Service Types

The WND-WR-MB meter supports any electrical service from 100 to 600 Vac, line-to-neutral or line-to-line, 50 to 60 Hz, single-phase, split-phase, or three-phase, wye or delta.

Connect the line voltages to the meter inputs as shown in the following figures for each service type. See **Figure 1** above for an overview.

Internally, the WattNode meter acts as three separate single-phase meters, one tied to each CT input. By default, CT1 is associated with V_{AN} (or $V_A - V_N$), CT2 with V_{BN} , and CT3 with V_{CN} . This default configuration may be changed using the **ConnectionType** register or the **MeterConfig** registers. See the **Reference Manual** for details.

When describing service types, the number of wires only includes neutral and line conductors, not the ground conductor.

2.2.1 Single-Phase, Two-Wire, Line-to-Neutral

This is a common residential and branch circuit connection. The CT should be placed around the line conductor and connected to the CT1 terminal (**Figure 2**). The meter will be powered from the V_N and V_A terminals.

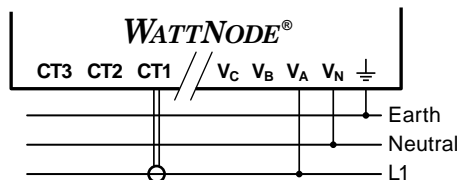

Figure 2: Single-Phase, Two-Wire, Line-to-Neutral

Up to three such circuits may be monitored with one meter using three CTs by connecting the second and third circuit line voltages to the V_B and V_C terminals and the additional CTs to CT2 and CT3 respectively as shown in **Figure 6**. It is also possible to monitor up to three circuits on the same voltage phase without connections to V_B and V_C ; see the **Reference Manual** for details.

2.2.2 Single-Phase, Two-Wire, Line-to-Line

This circuit occurs in residential (commonly 120/240 Vac) and some commercial applications (such as 208 or 480 Vac line-to-line). The meter will be powered from the V_A and V_B input terminals. Two CTs are typically used as shown below.

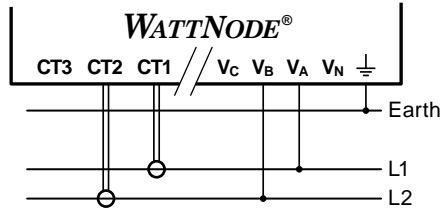

Figure 3: Single-Phase, Two-Wire, Line-to-Line with Two CTs

The [Reference Manual](#) documents two advanced configurations:

- By setting **ConnectionType = 5**, only one CT is required instead of two.
- One WattNode can monitor three single-phase, two-wire, line-to-line circuits.

2.2.3 Single-Phase, Three-Wire (Split-Phase)

This is a common North American residential service at 120/240 Vac with a neutral connection. The CTs should be placed around the L1 and L2 line conductors and connected to the **CT1** and **CT2** terminals respectively. The meter will be powered from the V_N , V_A , and V_B terminals.

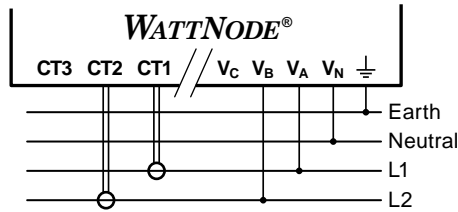

Figure 4: Single-Phase, Three-Wire

2.2.4 Three-Phase, Three-Wire Delta

This service is common in commercial and industrial settings. It does not include a neutral conductor. In some cases, the service may be four-wire wye while the load is three wire delta (no neutral). The meter will be powered from the V_A and V_B terminals.

With the default configuration, three CTs are required as shown below.

By setting **ConnectionType = 2**, only two CTs are required. See the [Reference Manual](#) for details.

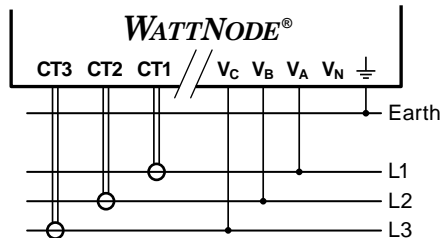

Figure 5: Three-Phase, Three-Wire Delta with Three CTs

2.2.5 Three-Phase, Four-Wire Wye

This is a common commercial and industrial service that includes a neutral conductor. The CTs should be placed around the L1, L2 and L3 line conductors and connected to the **CT1**, **CT2**, and **CT3** terminals respectively. The meter will be powered from the **V_N**, **V_A**, and **V_B** terminals.

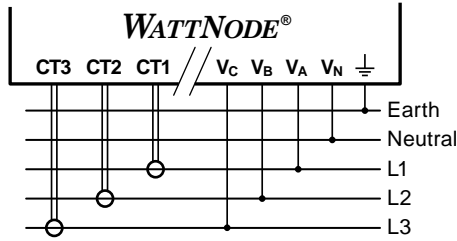

Figure 6: Three-Phase Four-Wire Wye with Neutral

2.2.6 Grounded Leg Service

In rare cases with delta services or single-phase two-wire, line-to-line services, one of the phases may be grounded.

The meter will correctly measure services with a grounded leg, but the measured voltage and power for the grounded phase will be zero. The status LEDs will not light for the grounded phase because the voltage is near zero. This type of service may result in unusual power factors.

See the web article [Corner-Grounded Delta Circuits](#) for more information.

2.2.7 Four-Wire Delta Service

There are several names for this service type including “high-leg”, “wild-leg”, “stinger leg”, or “wild phase”. This is a three-phase delta service with a center-tap on one of the transformer windings to create a neutral for single-phase loads. These occur in North America in two configurations: 120/208/240 Vac and 240/415/480 Vac.

With the WattNode Wide-Range meter, this service type can be measured just like any three-phase, four-wire wye service (**Figure 6**) using three CTs. By convention, you should connect the **V_B** terminal to the high leg. See [Four-Wire Delta Circuits](#) for more information.

3 Installation

3.1 Installation Checklist

See the sections referenced below for installation details.

- Turn off power before making line voltage connections.
- Mount the meter (see 3.2).
- Connect circuit breakers or fuses and disconnects (see 3.3.1).
- Connect the line voltage wires to the meter’s green terminal block (see 3.3.2).
- Mount the CTs around the line conductors. Make sure the CTs face the source (see 3.4).
- Connect the twisted white and black wires from the CTs to the black terminal block on the meter, matching the wire colors to the white and black dots on the meter label (see 3.4.2).
- Check that the CT phases match the line voltage phases: **CT1** with **V_A**, **CT2** with **V_B**, and **CT3** with **V_C**, unless you have specially configured the **ConnectionType** or **MeterConfig** registers (see 3.4).
- Record the CT rated current for each CT. They will be required during commissioning.
- Connect the output terminals of the meter to the monitoring equipment (see 3.5).
- Check that all the wires are securely installed in the terminal blocks by tugging on each wire.
- Turn on power to the meter.
- Verify that the LEDs indicate correct operation (see 4.2, 4.3).

3.2 Mounting

- Protect the meter from temperatures below -40°C (-40°F) or above 80°C (176°F), excessive moisture, dust, salt spray, or other contamination, using a NEMA rated enclosure if necessary. The meter requires an environment no worse than pollution degree 2 (normally only non-conductive pollution; occasionally, a temporary conductivity caused by condensation).
- The meter must be installed in an electrical service panel or an enclosure.
- **Do not** use the meter as a drilling guide; the drill chuck can damage the screw terminals and metal shavings may fall into the connectors.

The meter has two mounting holes spaced 5.375 in. (137 mm) apart (center-to-center). These mounting holes are normally obscured by the detachable screw terminals. Remove the screw terminals to mark the hole positions and mount the meter.

Self-tapping #8 sheet metal screws are included. Do not over-tighten the screws, as long-term stress on the case can cause cracking.

3.3 Connect Voltage Terminals

3.3.1 Circuit Protection

The WattNode meter is considered “permanently connected equipment” and requires a disconnect means (circuit breaker or disconnect switch) and overcurrent protection (fuse or circuit breaker).

The meter draws less than 0.1 amp, so the rating of any disconnects, fuses, and/or circuit breakers is determined by the wire gauge, the mains voltage, and the current interrupting rating required.

- The disconnect or circuit breaker must be clearly marked, suitably located, and easily reached.
- Use circuit breakers or fuses rated for 20 amps or less, and rated for the service voltage.
- Use ganged circuit breakers when monitoring more than one line voltage.
- The circuit breakers or fuses must protect whichever of the mains terminals **V_A**, **V_B**, or **V_C** are connected to the mains. Neutral does not need overcurrent protection.
- The circuit protection / disconnect system must meet IEC 60947-1 and IEC 60947-3, as well as all national and local electrical codes.

3.3.2 Line Wiring

- **Always turn off power** before connecting the line voltages to the meter.
- For the line voltage wires, CCS recommends 18 to 12 AWG stranded wire, type THHN, MTW, or THWN, 600 V.
- Use copper conductors only. The screw terminals are only rated for copper wire.
- Do not place more than one wire in a screw terminal; use wire nuts or terminal blocks if needed.
- Verify that the highest line-to-neutral or line-to-line voltage is nominally between 100 and 600 Vac. The absolute maximum operating voltage is 690 Vac.

Connect each service conductor to the green terminal block as shown in section 2 above. Torque the screws to 4.4 lbf-in (0.5 N·m).

The screw terminals handle wire up to 12 AWG. Connect each voltage line to the green terminal block as shown in **Figure 1** through **Figure 6** above. After connecting the voltage wires, make sure both terminal blocks are fully seated in the meter.

3.3.3 Grounding

The WattNode uses a plastic enclosure, insulation, and internal isolation barriers instead of protective earthing. The ground terminal on the green screw terminal block is a functional ground, designed to improve the measurement accuracy and noise immunity. If necessary, this terminal may be left disconnected.

3.4 Connect Current Transformers

To meet the UL listing requirements, the meter must be used with UL Listed or UL Recognized current transformers. Only UL Listed CTs are approved for use in retrofit applications in panelboards; recognized CTs must not be used for this application.

The standard meter supports CTs with a 0.33333 Vac output (one-third volt). With the correct options, the meter can support CTs with a 40 milliamp output: contact CCS for details.

3.4.1 Current Transformer Installation

See the web article [Selecting Current Transformers](#) for information on selecting appropriate current transformers (CTs).

- **WARNING:** To reduce the risk of electric shock, always open or disconnect circuit from power-distribution system or service of the building before installing or servicing current transformers.
- **WARNING:** When using UL Recognized CTs, they must be installed on insulated conductors only and maintained away from all live parts.
- **Do not** use 1 amp or 5 amp current output CTs!
- The CTs are not suitable for Class 2 wiring methods and must be treated as Class 1 circuits.
- Use plastic cable ties to secure the current transformers and route the lead wires so that they do not directly contact uninsulated live terminals or conductors.
- Split-core CTs can be opened for installation around a conductor. A nylon cable tie may be secured around the perimeter of the CT to prevent inadvertent opening.
- Do not install current transformers where they would: 1) exceed 75 percent of the wiring space of any cross-sectional area within the equipment, 2) would block ventilation openings, or 3) would be in an area of breaker arc venting.
- See the CT datasheets for the maximum input current ratings.
- To minimize current measurement noise, avoid extending the CT wires beyond 100 feet (30 meters), especially in noisy environments. If it is necessary to extend the wires, use twisted pair wire 22 to 14 AWG, rated for 300 V or 600 V (not less than the service voltage) and shielded if possible.

Find the source arrow or label "THIS SIDE TOWARD SOURCE" on the CT and face/point toward the source of current. CTs are directional, so if they are mounted backwards or with their white and black wires swapped the measured power will be negative. The power status LEDs indicate negative measured power by flashing red.

Install the CTs around the phase conductors to be measured as shown in **Figure 1** through **Figure 6** above. Connect the CT leads to the meter.

For revenue accuracy, use revenue-grade current transformers; other CTs are less accurate and may not provide revenue accuracy. Contact sales for more information on appropriate CTs.

3.4.2 CT Wiring

The current transformers connect to the six-position black screw terminal block. Connect the white and black CT wires to the meter terminals marked **CT1**, **CT2**, and **CT3** (see **Figure 1** above). Excess length may be trimmed from the wires if desired. Connect each CT with the white wire aligned with the white dot on the label, and the black wire aligned with the black dot. Note the order in which the phases are connected, as the line voltage phases **must** match the current phases for accurate power measurement. Torque the screws to 4.4 lbf-in (0.5 N·m).

3.5 RS-485 Communication

3.5.1 RS-485 Cables

There are many choices for RS-485 cabling. Ideally use cable specifically rated for RS-485 applications as it will have the best impedance for long distances to minimize interference and reflections. However, for distances up to 100 meters, especially at baud rates of 38,400 or lower, a special RS-485 cable is normally not required. See [RS-485 Cables for Modbus](#) for more information.

There are some common conductor configurations for RS-485 cables:

- Two conductors without shield: we do not recommend using this type of cable because our meter expects the common terminal to be connected.
- Two conductors with shield: use the two conductors for the **A-** and **B+** terminals, use the shield for **C** (common). If the shield is connected to earth, it should only be connected at the Modbus master device.

- Three conductors without shield: use the three conductors for the **A-**, **B+**, and **C** (common). If two of the conductors are twisted together, use those for the **A-** and **B+** terminals.
- Three conductors with shield: use the three conductors for the **A-**, **B+**, and **C** (common). If two of the conductors are twisted together, use those for the **A-** and **B+** terminals. The shield may be connected to earth at the Modbus master device for improved noise immunity.
- If there are additional conductors, they may be left disconnected.
- Use twisted-pair cable to prevent interference.
- For longer distances (>30 meters) or electrically noisy environments, use shielded cable.

3.5.2 RS-485 Connection

RS-485 wiring can be complex when multiple devices are connected, when running wires for long distances, and when using termination and biasing resistors. If you have any questions, consult the [Reference Manual](#).

- The meter outputs are electrically isolated from dangerous voltages.
- If the output wiring is near line voltage wiring, use wires or cables with a 300 V or 600 V rating (not less than the service voltage).
- If the output wiring is near bare conductors, it should be double insulated or jacketed.
- RS-485 wiring is daisy-chained between meters, with up to 64 devices per subnet as shown in the figure below. Avoid a star or home run wiring system, where each device is wired back to the Modbus master, as this can cause signal reflections.
- You may install two wires into each screw terminal by twisting the wires together first.
- Torque the screws to 4.4 lbf-in (0.5 N·m).
- **Note:** one loose wire can disable an entire network section.
- **Note:** the X terminal is not active on the WattNode Wide-Range meter.

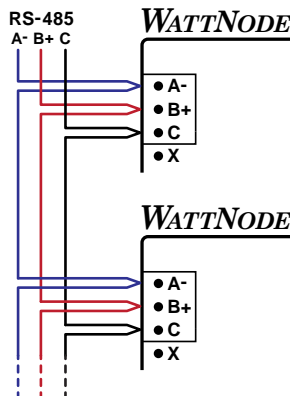

Figure 7: RS-485 Wiring

3.5.3 Modbus RTU

The WattNode meter can be connected to PCs with RS-485 interfaces, gateways, data loggers, and other devices that accept RS-485 Modbus RTU.

Use DIP switches 1-6 to select the Modbus address (1 to 63).

DIP Switch	1	2	3	4	5	6
Up (1) Value	1	2	4	8	16	32
Address	Examples					
1	1, Up	0, Down	0, Down	0, Down	0, Down	0, Down
1+2+4 = 7	1, Up	1, Up	1, Up	0, Down	0, Down	0, Down
4+16 = 20	0, Down	0, Down	1, Up	0, Down	1, Up	0, Down
1+2+16+32 = 51	1, Up	1, Up	0, Down	0, Down	1, Up	1, Up

Select the RS-485 termination with DIP switch position 7 (see below). The change will take effect immediately.

Termination	DIP Switch 7
none (default)	0, Down
120 ohms	1, Up

Select the baud rate with DIP switch position 8 (see below). The change will take effect immediately. Baud rates up to 115,200 baud may be factory configured or programmed using the **BaudRate** register.

Baud Rate	DIP Switch 8
9,600 (default)	0, Down
19,200	1, Up

The RS-485 settings default to no parity, 8 data bits, and 1 stop bit (N81). Other parity and stop bit settings may be configured with factory options or with the Modbus **ParityMode** register.

4 Operation

4.1 Initial Configuration

Generally, the network integrator will remotely configure the WattNode meter and the variables. For details on configuring the WattNode meter, see the appropriate [Reference Manual](#) for your model.

The meter does not include a display or buttons, so it is not possible to configure or monitor the meter directly, other than the basic LED diagnostics described below.

At a minimum, the **CtAmps** must be programmed with the rated current (amps) of the attached current transformers for correct measurements. If you are using a potential transformer, then you will also need to configure the **PtRatio** register with the correct ratio. See the website article [Using Potential Transformers](#) for details.

4.2 Power Status LEDs

The three status LEDs on the front of the meter can help indicate correct measurements and operation. The "CT1", "CT2", and "CT3" on the diagrams indicate the three phases.

4.2.1 Normal Startup

The meter displays the following startup sequence whenever power is first applied.

CT1	Red	Yellow	Green
CT2	Red	Yellow	Green
CT3	Red	Yellow	Green
	1.0sec	1.0sec	1.0sec

4.2.2 Positive Power

Any phase with the LEDs flashing green is indicating normal positive power.



4.2.3 No Power

Any phase with a solid green LED indicates no power, but line voltage is present.



4.2.4 No Voltage

Any phase LED that is off indicates no voltage on that phase.

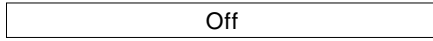

4.2.5 Negative Power

Red flashing indicates negative power for that phase. Reversed CTs, swapped CT wires, or CTs not matched with line voltage phases can cause this.



4.2.6 Overvoltage Warning

The following indicates that the line voltage is too high for this model. **Disconnect power immediately!** Check the line voltages and the meter ratings (in the white box on the label).

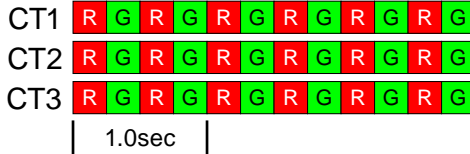

4.2.7 Meter Not Operating

If none of the LEDs light, then check that the correct line voltages are applied to the meter. If the voltages are correct, call customer service for assistance.

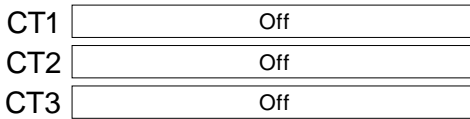

4.2.8 WattNode Error





If the meter experiences an internal error, it will light all LEDs red for three or more seconds. If you see this happen repeatedly, return the meter for service.



For other LED patterns, see the [Reference Manual](#) or contact support for assistance.

4.3 Modbus Communication LED

Near the upper left corner, there is a diagnostic **Com** (communication) LED that can indicate the following:

-  Off A short green flash indicates a valid packet addressed to this device.
-  Off Short yellow flashes or rapid flashing indicate valid packets addressed to different devices.
-  A one second red flash indicates an invalid packet: incorrect baud rate, bad CRC, noise, incorrect parity, etc.
-  Rapid red/yellow flashing indicates a possible address conflict (two devices with the same DIP switch address).
-  Solid red indicates the address is set to zero: an invalid choice.

4.4 Monitoring

The WattNode Wide-Range Modbus meter models communicate measurements over a Modbus RTU network. The measurements include: energy, power, voltage, current, line frequency, power factor, reactive power, and demand.

In order to monitor and configure networked WattNode models, you will need an appropriate monitoring solution, either standalone or PC software.

See the [Reference Manual](#) for a complete list of network accessible variables.

4.5 Maintenance and Repair

The WattNode meter requires no maintenance. It is not user serviceable and there are no replaceable parts except the pluggable screw terminals. There are no diagnostic tests that can be performed by the user, other than checking for errors via the Modbus interface or the status LEDs.

In the event of any failure, the meter must be returned for service (contact CCS for an RMA). For a new installation, follow the troubleshooting instructions in the [Reference Manual](#) before returning the meter for service, to ensure that the problem is not connection related.

The WattNode meter should not normally need to be cleaned, but if cleaning is desired, power must be disconnected first and a dry or damp cloth or brush should be used.

5 Specifications

The following is a list of basic specifications. For extended specifications, see the [WND-WR-MB-Meter-Datasheet](#).

5.1 Measurement

Update Rate: 0.1 second. Internally, all measurements are performed at this rate, except the energy registers, which are updated every 1.0 second.

Start-Up Time: ≤ 1 second after the supply voltage is applied.

Default CT Phase Angle Correction: 0.0 degrees.

5.2 Electrical

Nominal Power Supply Voltage: 100 to 600 Vac

Power Supply Input Terminals: V_N , V_A , and V_B (the meter supply can operate line-to-neutral or line-to-line)

Power Supply Minimum Operating Voltage: 85 Vac

Power Supply Absolute Maximum Voltage: 690 Vac. Exceeding this limit can damage the WattNode and void the warranty.

Power Supply Watts: typical 1.0 W, maximum 2.5 W

Power Supply Voltage-Amperes: ≤ 20 mA

Power Supply Power Factor: typically 0.6

Nominal Line-to-Neutral Vac: 100 to 347 Vac

Nominal Line-to-Line Vac: 120 to 600 Vac

Over-Current Limit: 200% of rated current. Exceeding 200% of rated current will not harm the WattNode meter but the current and power will not be measured accurately.

Maximum Surge: EN 61000-4-5: 4kV, ANSI C12.1: 6kV, 1.2/50 μ s — 8/20 μ s

Operating Frequencies: 50/60 Hz

Measurement Category: The line voltage measurement terminals on the meter are rated for CAT III, 600 Vac

Measurement Category III is for measurements performed in the building installation. Examples are measurements on distribution boards, circuit-breakers, wiring, including cables, bus-bars, junction boxes, switches, socket-outlets in the fixed installation, and equipment for industrial use and some other equipment, for example, stationary motors with permanent connection to the fixed installation.

Current Transformer Inputs:

Voltage Mode:

Nominal Input Voltage (At CT Rated Current): 0.33333 Vac RMS

Absolute Maximum Input Voltage: 5.0 Vac RMS

Input Impedance at 50/60 Hz: 23 k Ω

Current Mode (Opt MA):

Nominal Input Current (At CT Rated Current): 40 mA RMS

Absolute Maximum Input Current: 200 mA RMS

Input Impedance at 50/60 Hz: 10 Ω

5.3 EIA RS-485 Interface

RS-485 Output Isolation: 4500 Vac RMS

Driver Output:

- **Voltage (Open Circuit):** ± 6 Vdc maximum
- **Voltage (54 Ω load):** ± 1.5 Vdc minimum
- **Current (54 Ω load):** ± 60 mA typical
- **Rise Time (54 Ω || 50 pF load):** 900 nS typical

Receiver:

- **Common-Mode Range:** -7 Vdc to +12 Vdc max
- **Sensitivity:** ± 200 mV
- **Bus Load:** 1/8 unit load (up to 64 meters)
- **Failsafe Modes:** bus open, shorted, and idle

5.4 Certifications

Safety:

- **UL 61010-1:** 3rd Edition, UL file number E359088
- **CAN/CSA-C22.2 No. 61010-1-12**
- **IEC 61010-1:2010**

Emissions:

- **FCC Part 15:** Class B, radiated and conducted emissions
- **CISPR / EN 55022:** 1994, Class B, radiated and conducted emissions

EMC Requirements: EN 61326-1: 2013, industrial locations

- **Electrostatic Discharge:** EN/IEC 61000-4-2: (B) Self-Recovering
- **Radiated RF Immunity:** EN/IEC 61000-4-3: (A) No Degradation
- **Electrical Fast Transient / Burst:** EN/IEC 61000-4-4: (A) No Degradation

- **Surge Immunity:** EN/IEC 61000-4-5: (A) No Degradation
- **Conducted RF Immunity:** EN/IEC 61000-4-6: (A) No Degradation
- **Power Frequency H-field Immunity:** EN/IEC 61000-4-8: (A) No Degradation
- **Voltage Dips, Interrupts:** EN/IEC 61000-4-11: (B) Self-Recovering

RoHS Compliant: European Parliament Directive 2011/65/EU: Hazardous Substances

5.5 Environmental

Operating Temperature: -40°C to 80°C (-40°F to 176°F)

Altitude: Up to 3000 m (9842 ft)

Operating Humidity: non-condensing, 5 to 90% relative humidity (RH) up to 40°C, decreasing linearly to 50% RH at 55°C.

Pollution: POLLUTION DEGREE 2 - Normally only non-conductive pollution; occasionally, a temporary conductivity caused by condensation must be expected.

Indoor Use: Suitable for indoor use.

Outdoor Use: Suitable for outdoor use if mounted inside an electrical enclosure (Hammond Mfg., Type EJ Series) rated NEMA 3R or 4 (IP 66).

5.6 Mechanical

Enclosure: High impact, ABS/PC plastic

Flame Resistance Rating: UL 94V-0, IEC FV-0

Size: 6.02 in. x 3.35 in. x 1.50 in. (153 mm x 85 mm x 38 mm)

Connectors: Euroblock pluggable terminal blocks

Green: up to 12 AWG (2.5 mm²), 600 V, screw torque 4.4 lbf-in (0.5 N-m)

Black: up to 12 AWG (2.5 mm²), 300 V, screw torque 4.4 lbf-in (0.5 N-m)

Weight: 233 g (8.2 oz)

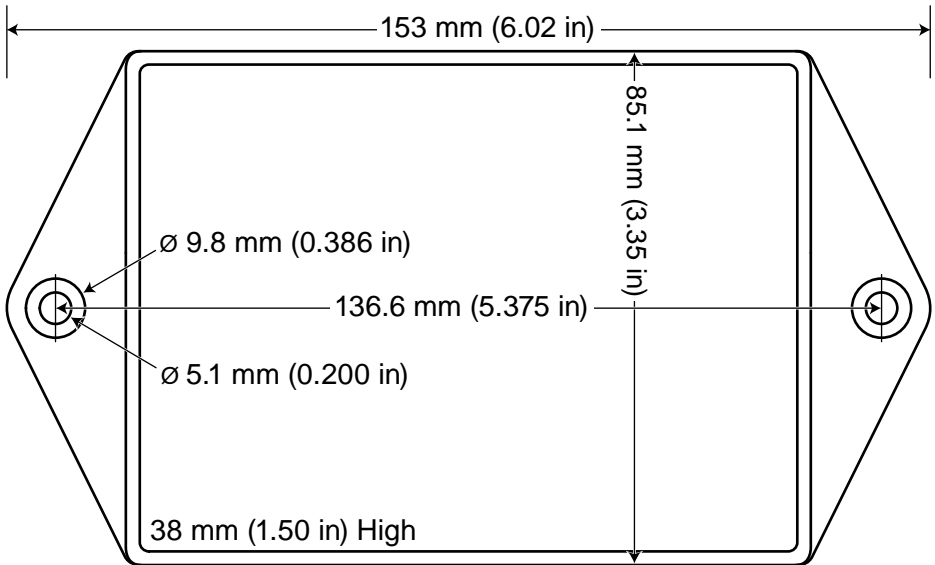

5.7 FCC Information

This equipment has been tested and complies with the limits for a Class B digital device, pursuant to part 15 of the FCC Rules. Operation is subject to the following two conditions: (1) This device may not cause harmful interference, and (2) this device must accept any interference received, including interference that may cause undesired operation.

The FCC limits are designed to provide reasonable protection against harmful interference in a residential installation. This equipment generates, uses and can radiate radio frequency energy and, if not installed and used in accordance with the instructions, may cause harmful interference to radio communications. However, there is no guarantee that interference will not occur in a particular installation. If this equipment does cause harmful interference to radio or television reception, which can be determined by turning the equipment off and on, the user is encouraged to try to correct the interference by one or more of the following measures:

- Reorient or relocate the receiving antenna.
- Increase the separation between the equipment and receiver.
- Connect the equipment to a circuit different from that to which the receiver is connected.
- Consult the dealer or an experienced radio/TV technician for help.

5.8 Warranty

All products sold by Continental Control Systems, LLC (CCS) are guaranteed against defects in material and workmanship for a period of five years from the original date of shipment. CCS's responsibility is limited to repair, replacement, or refund, any of which may be selected by CCS at its sole discretion. CCS reserves the right to substitute functionally equivalent new or serviceable used parts.

This warranty covers only defects arising under normal use and does not include malfunctions or failures resulting from: misuse, neglect, improper application, improper installation, water damage, acts of nature, lightning, product modifications, alterations or repairs by anyone other than CCS.

Except as set forth herein, CCS makes no warranties, expressed or implied, and CCS disclaims and negates all other warranties, including without limitation, implied warranties of merchantability and fitness for a particular purpose.

5.9 Limitation of Liability

In no event shall CCS be liable for any indirect, special, incidental, punitive or consequential damages of any kind or nature arising out of the sale or use of its products whether such liability is asserted on the basis of contract, tort or otherwise, including without limitation, lost profits, even if CCS has been advised of the possibility of such damages.

Customer acknowledges that CCS's aggregate liability to Customer relating to or arising out of the sale or use of CCS's products, whether such liability is asserted on the basis of contract, tort or otherwise, shall not exceed the purchase price paid by Customer for the products in respect of which damages are claimed. Customer specifically acknowledges that CCS's price for the products is based upon the limitations of CCS's liability set forth herein.

©2009-2021 Continental Control Systems, LLC.
Document ID: WND-WR-MB-Inst-1.05
Revision Date: May 19, 2021

Continental Control Systems, LLC
+1-303-444-7422, <https://ctlsys.com>

- WattNode is a registered trademark of Continental Control Systems, LLC.
- Modbus is a registered trademark of Schneider Automation Inc.

(M14)
Rev 1.05