



Features

- Rated currents: 150, 250, 300, 400, and 600 amps
- Revenue-grade accuracy:
 - IEEE C57.13 class 0.3
 - IEC 61869-2 class 0.2S
- Excellent gain and phase performance
- Nominal gain accuracy: $\pm 0.20\%$
- Nominal phase accuracy: $\pm 0.125^\circ$ (± 7.5 minutes)
- Integral burden resistor, no shorting block needed
- Opening: 1.77 x 1.26 in. (45.0 x 32.0 mm)
- Handles two 350 kcmil or one 750 kcmil conductor
- Can be wired in parallel
- UL Listed (UL 2808, XOBA)
- A certificate of calibration is available upon request

Links

- **Product page:** <https://ctlsys.com/p/actl-1250/>
- **Manual:** <https://ctlsys.com/m/ACTL-1250-CT-Manual.pdf>
- <https://ctlsys.com/s/measuring-parallel-conductors/>

Patents

- U.S. Patent 8,847,576

1 Models and Options

Table 1: Models

	Rated Primary Current	Maximum Current	Output at Rated Amps	Line Frequency	Internal Burden (Ohms)
ACTL-1250-150 Opt C0.2,60Hz	150 A	720 A	0.33333 Vac	60 Hz	13.3
ACTL-1250-250 Opt C0.2,60Hz	250 A	720 A	0.33333 Vac	60 Hz	8.00
ACTL-1250-300 Opt C0.2,60Hz	300 A	720 A	0.33333 Vac	60 Hz	6.67
ACTL-1250-400 Opt C0.2,60Hz	400 A	720 A	0.33333 Vac	60 Hz	5.00
ACTL-1250-600 Opt C0.2,60Hz	600 A	720 A	0.33333 Vac	60 Hz	3.33
ACTL-1250-150 Opt C0.2,50Hz	150 A	720 A	0.33333 Vac	50 Hz	13.3
ACTL-1250-250 Opt C0.2,50Hz	250 A	720 A	0.33333 Vac	50 Hz	8.00
ACTL-1250-300 Opt C0.2,50Hz	300 A	720 A	0.33333 Vac	50 Hz	6.67
ACTL-1250-400 Opt C0.2,50Hz	400 A	720 A	0.33333 Vac	50 Hz	5.00
ACTL-1250-600 Opt C0.2,50Hz	600 A	720 A	0.33333 Vac	50 Hz	3.33

Rated Primary Current: also called “rated amps”, this is the nominal full-scale current rating for the sensor. At the rated primary current, the CT will output its nominal output of 0.33333 Vac. The accuracy is specified at percentages of the rated primary current.

Maximum Current: also called “maximum continuous amps” or “max amps” is the UL Listing maximum continuous current rating for a particular sensor model.

Note: ACTL-1250 part numbers are equivalent to ACT-1250 parts.

Note: the ACTL-1250 is also available in standard and Opt C0.6 versions. These are documented in a separate datasheet.

Note: the burden resistor is built into the ACTL-1250.

⚠ WARNING: This product can expose you to chemicals including antimony trioxide, which is known to the State of California to cause cancer. For more information go to: www.P65Warnings.ca.gov

1.1 Options

1.1.1 Opt C0.6

Option C0.6 provides IEEE C57.13 class 0.6 accuracy and is documented in a separate datasheet: "ACTL-1250-Datasheet".

1.1.2 Opt C0.3

Option C0.3 provides IEEE C57.13 class 0.3 accuracy and is documented in a separate datasheet: "ACTL-1250-C0.3-Datasheet".

1.1.3 Opt C0.2

With Option C0.2, the Accu-CT accuracy increases to 0.2% and meets IEEE/ANSI C57.13-2008 class 0.3 accuracy and IEC 61869-2 class 0.2 and class 0.2S accuracy. See **Specifications** below for details.

- ACTL-1250 models with Opt C0.2 for use on 50 Hz electrical systems should be ordered with option 50 Hz for best accuracy.

1.1.4 Opt 60Hz

Calibrate the CT for best accuracy at 60 Hz. This is the default calibration, but the option is included to make it clear that Opt C0.2 CTs must be calibrated specifically for 50 or 60 Hz. We recommend all customers order with Opt 60Hz or Opt 50Hz.

1.1.5 Opt 50Hz

Calibrate the CT for best accuracy at 50 Hz instead of the standard 60 Hz. Without this option, the phase angle errors at 50 Hz may exceed the published limits.

1.1.6 Opt FT

The Accu-CT can be ordered with custom lead lengths. For example, Opt FT=20 for 20-foot leads. We also sell extra lead wire to allow for field extension of the leads. Option FT does not affect the accuracy specifications.

1.1.7 Opt M

The Accu-CT can be ordered with custom lead lengths. For example, Opt M=4 for 4-meter leads. We also sell extra lead wire to allow for field extension of the leads. Option M does not affect the accuracy specifications.

1.1.8 Opt 1V

This option is not available with Opt C0.2.

1.1.9 Opt HF

This option is not available with Opt C0.2.

2 Specifications

- **Nominal Line Frequency:** 50 or 60 Hz
- **Maximum Continuous Primary Current:** See **Table 1: Models**
- **Maximum Nominal Voltage:** 600 Vac
- **Overvoltage and Measurement Categories:**
 - 600 Vac, CAT IV (service entrance) for pollution degree 2
 - 250 Vac, CAT III for pollution degree 3
- **Output Lead Wires:**
 - **Standard length:** 8 ft (2.4 m)
 - **Gauge:** 20 AWG (18 AWG before March 2021)
 - **Type:** MTW, UL 1015
 - **Voltage:** 600 Vac

- **Temperature Rating:** 105°C
- **Style:** Two conductor: white and black, twisted
- **White:** current transformer positive (in-phase with current) signal
- **Black:** current transformer negative (180-degree out of phase to current) signal
- **Output:** Voltage output, integral burden resistor
 - **Output Voltage at Rated Amps:** see **Table 1: Models**
 - **Output Protection:** includes internal burden resistor and 9V Zener diode
- **Expected Load Resistance:** 23kΩ (see Effect of Output Loading section)

2.1 Accuracy

- **Opt C0.2 Output Accuracy:** all accuracy limits from -30°C to +55°C (-22°F to 131°F)
 - **Accuracy (% of reading):**
 - ±0.20% from 10% to 120% of rated current
 - ±0.30% from 1% to 9% of rated current
 - **Phase Angle:** within ±2 Hz from the nominal line frequency (either 50 Hz or 60 Hz)
 - ±0.125 degrees (7.5 minutes) from 10% to 120% of rated current
 - ±0.250 degrees (15 minutes) from 1% to 9% of rated current
 - **IEEE C57.13 Accuracy:** class 0.3
 - **TCF:** Between 0.997 and 1.003 from 10% to 120% of rated current
 - **IEC 60044-1 and IEC 61869-2 Accuracy:**
 - class 0.2 from 5% to 120% of rated current
 - class 0.2S from 1% to 120% of rated current
- **Conductor Position Sensitivity:** typical ±0.06%, maximum ±0.10%
 The quoted gain accuracy is with the measured conductor centered in the CT opening. Moving the conductor off-center may cause small accuracy errors. The following diagram shows the typical accuracy errors at various positions. The phase angle error varies by less than 0.01 degrees (0.6 minutes) at different positions.

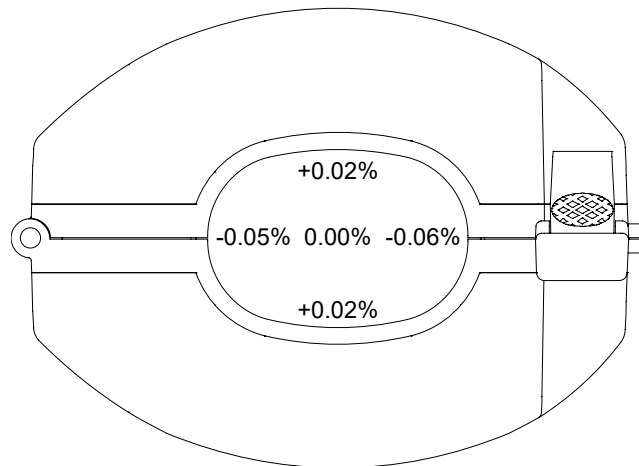

2.2 Regulatory

- CE
- **UL:** UL listed, X0BA, UL 2808, CAN/CSA-C22.2 No. 61010-1, E363660
- RoHS Compliant

2.3 Environmental

- **Operating Temperature:** -30°C to +75°C (-22°F to 167°F); accuracy only specified up to +55°C (131°F)
- **Operating Humidity:** Non-condensing, 5 to 95% relative humidity (RH)
- **Operating Altitude:** Up to 3000m
- **Pollution Degree:**
 - 2 (controlled environment) for CAT IV, 600 Vac
 - 3 (harsh environment) for CAT III, 250 Vac

- **Indoor Use:** Suitable for indoor use
- **Outdoor Use:** Suitable for outdoor use when mounted in a NEMA 3R or 4 (IP 66) rated enclosure, provided the ambient temperature will not exceed 75°C (167°F)

2.4 Mechanical

- **Width:** 4.50 in. (114.0 mm ± 1.0 mm)
- **Height:** 3.30 in. (83.4 mm ± 1.0 mm)
- **Thickness:** 1.58 in. (40.2 mm ± 0.5 mm)
- **Opening:** 1.77 x 1.26 in. (45.0 x 32.0 mm ± 0.5 mm)
- **Weight:** 13.9 oz (395 gm)
- **Housing Material:** Valox PBT, 94V-0 flame rating
- **Core Material:** high permeability ferrite

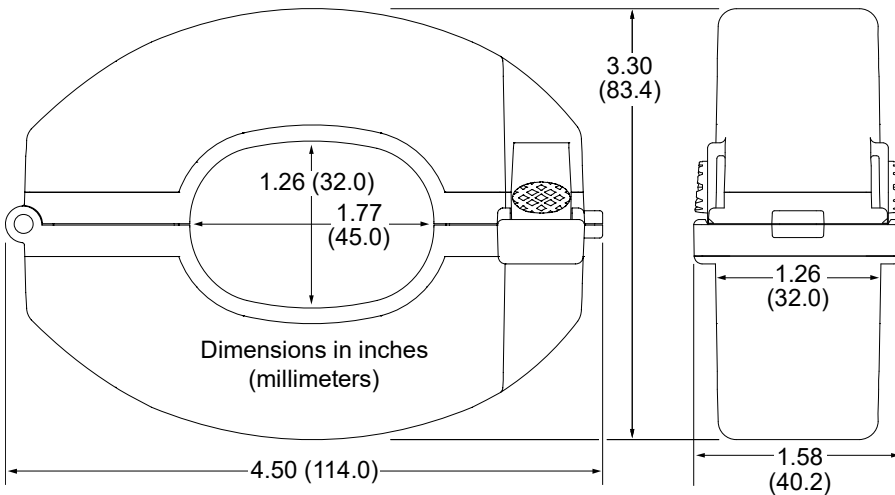

2.5 Miscellaneous

- Assembled in USA
- **Label barcode:** QR Code, "Model ; SerialNum"

3 Typical Accuracy

In the following graphs, a positive phase angle error indicates that the output of the CT leads the primary current.

3.1 60 Hz Models

The following models are optimized for best phase angle performance at 60 Hz.

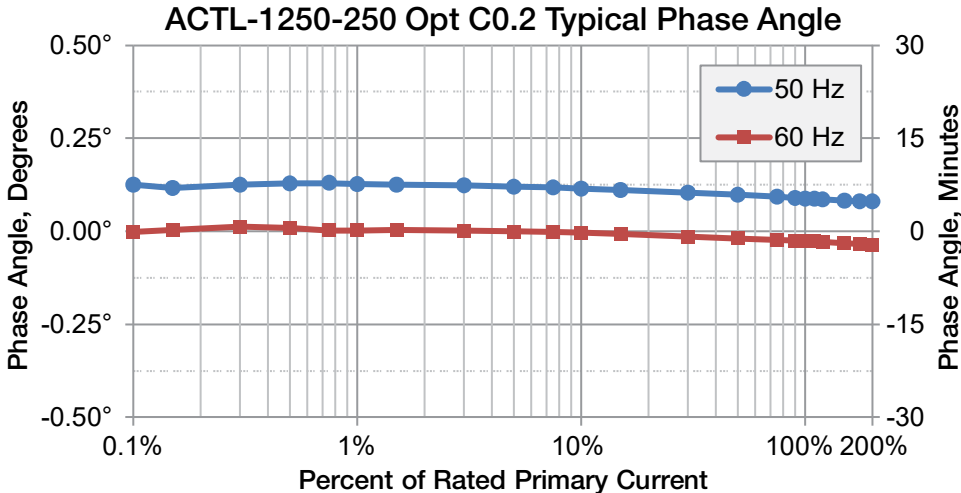
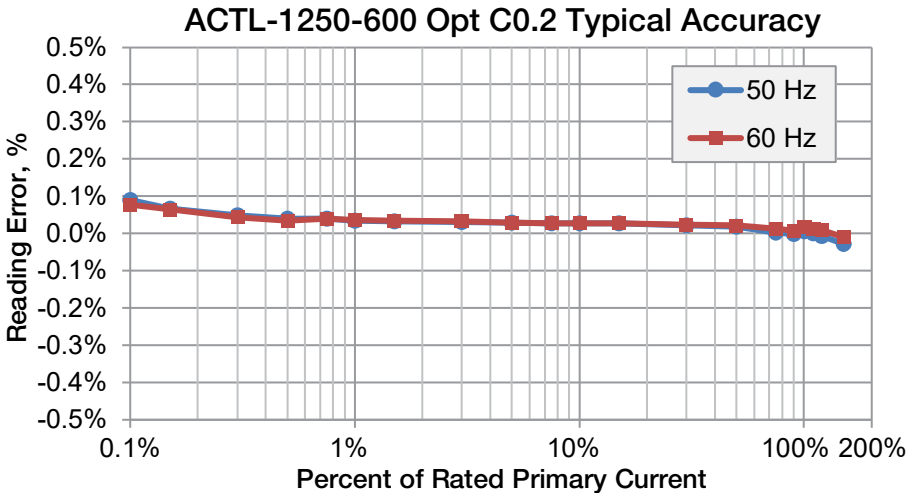
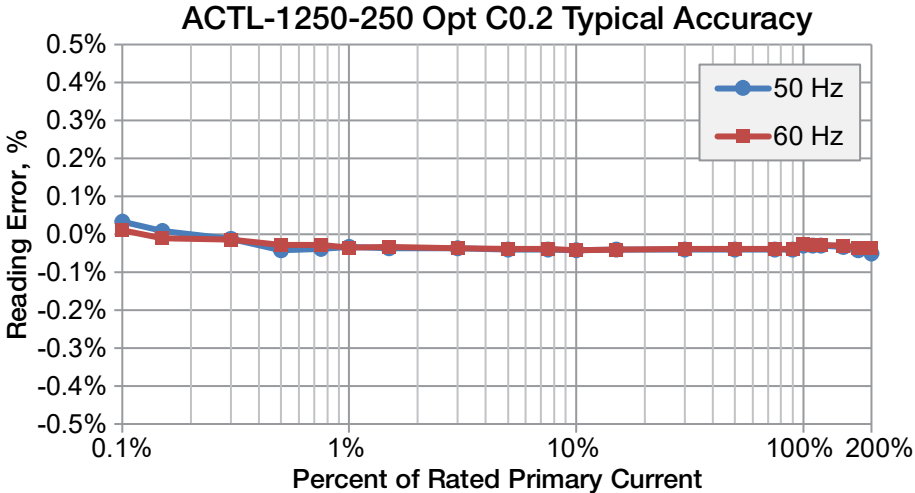

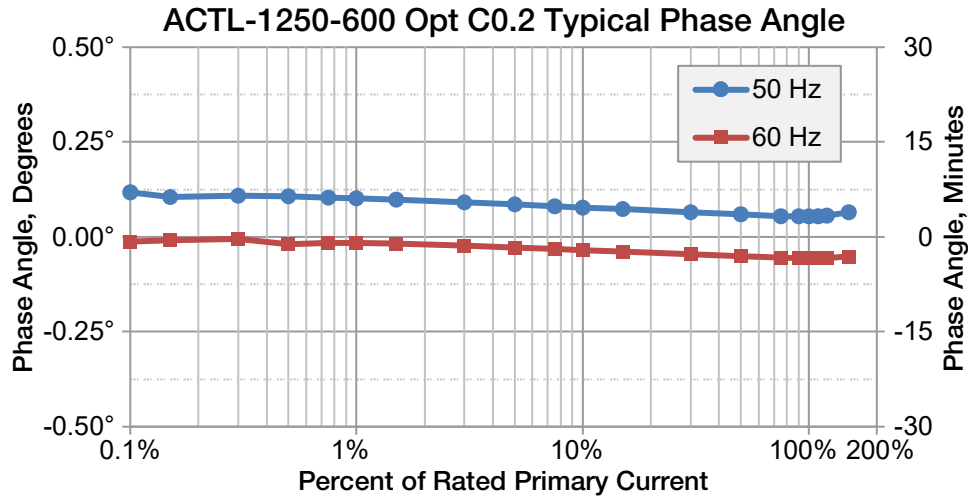

3.2 50 Hz Models

The following models are optimized for best phase angle performance at 50 Hz.

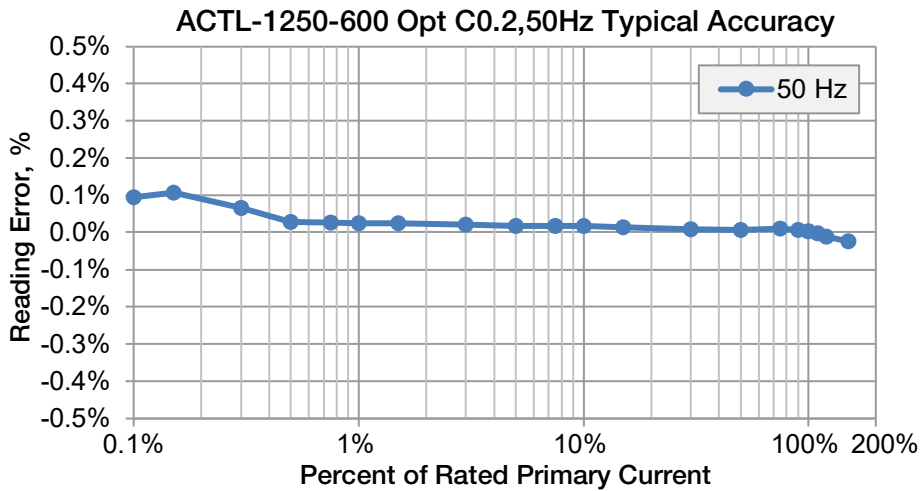
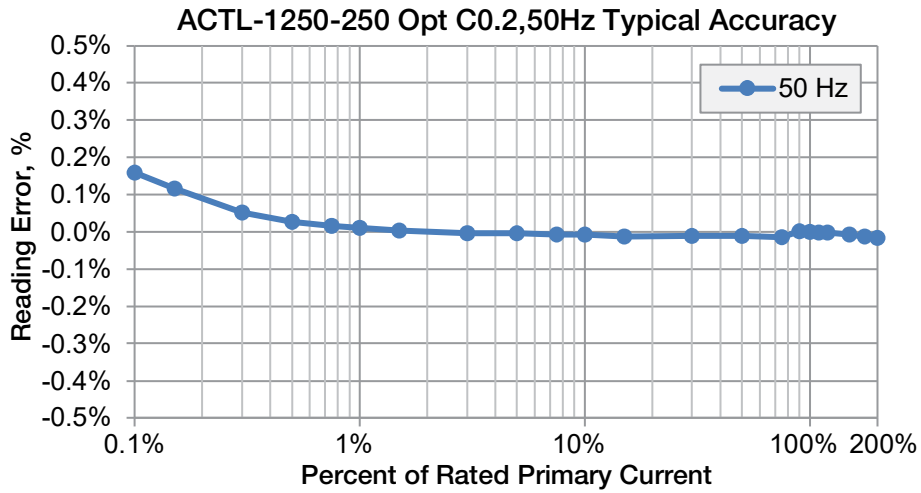

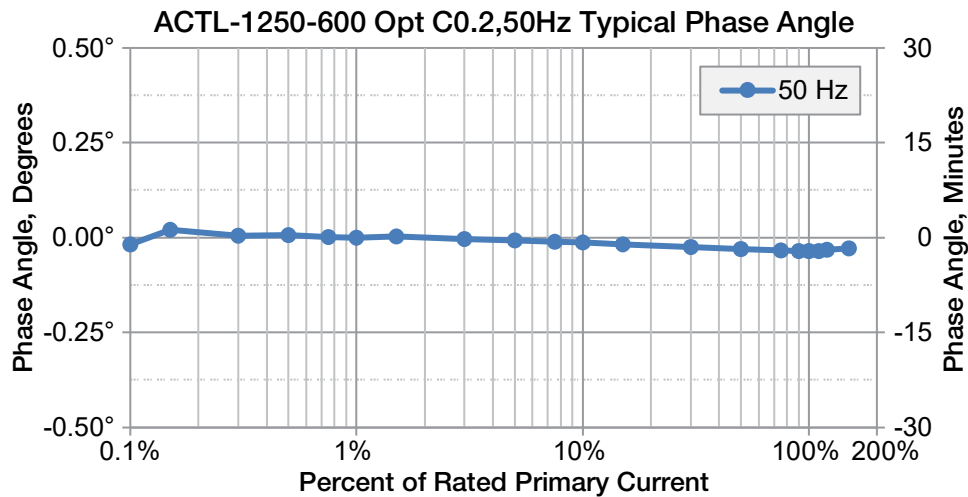
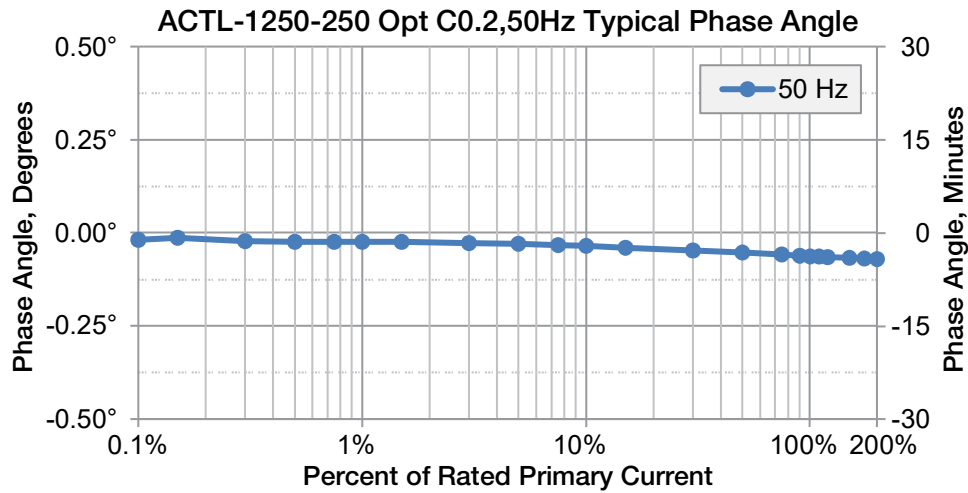

3.3 Effect of Output Loading

If you are using the ACTL-1250 series current transformers with a WattNode meter, you may disregard this section because the ACTL-1250 CTs have been optimized for the standard 23kΩ loading of a WattNode meter. For anything other than a WattNode meter, the meter’s input impedance may affect the gain of the CT, because the meter’s input impedance appears as an output load to the current transformer.

The ACTL-1250 series current transformers are designed with an expected output loading of 23kΩ. Different actual loadings will cause small shifts in the gain. A higher load than expected will result in higher gain, while a lower load will result in a lower gain. The phase angle error is not materially affected by the loading.

The worst-case effect of different loads follows:

- 1.0MΩ load: gain will be high by 0.06% or less
- 10kΩ load: gain will be low by 0.13% for ACTL-1250-150, low by 0.08% or less for other models

To precisely compute the effect of non-standard output loadings, use the following.

R_B = CT Burden Resistance (see **Table 1: Models**)

R_E = Expected Output Loading (23kΩ)

R_A = Actual Output Loading

$e\%$ = Gain Error (percentage)

$$e\% = 100 \frac{R_B(R_A - R_E)}{R_E(R_B + R_A)}$$

Examples:

ACTL-1250-400 with 10kΩ load: $R_B = 5, R_E = 23000, R_A = 10000, e\% = +0.021\%$ (low)

ACTL-1250-400 with 1.0MΩ load: $R_B = 5, R_E = 23000, R_A = 1,000,000, e\% = -0.028\%$ (low)